

EW-7438RPn

User Manual

07-2012 / v1.2



COPYRIGHT

Copyright © Edimax Technology Co., Ltd. all rights reserved. No part of this publication may be reproduced, transmitted, transcribed, stored in a retrieval system, or translated into any language or computer language, in any form or by any means, electronic, mechanical, magnetic, optical, chemical, manual or otherwise, without the prior written permission from Edimax Technology Co., Ltd.

Edimax Technology Co., Ltd. makes no representations or warranties, either expressed or implied, with respect to the contents hereof and specifically disclaims any warranties, merchantability, or fitness for any particular purpose. Any software described in this manual is sold or licensed as is. Should the programs prove defective following their purchase, the buyer (and not this company, its distributor, or its dealer) assumes the entire cost of all necessary servicing, repair, and any incidental or consequential damages resulting from any defect in the software. Edimax Technology Co., Ltd. reserves the right to revise this publication and to make changes from time to time in the contents hereof without the obligation to notify any person of such revision or changes.

The product you have purchased and the setup screen may appear slightly different from those shown in this QIG. For more information about this product, please refer to the user manual on the CD-ROM. The software and specifications are subject to change without notice. Please visit our website www.edimax.com for updates. All brand and product names mentioned in this manual are trademarks and/or registered trademarks of their respective holders.

Edimax Technology Co., Ltd.

Add: No. 3, Wu-Chuan 3rd Rd., Wu-Ku Industrial Park, New Taipei City, Taiwan

Tel: +886-2-77396888

Email: sales@edimax.com.tw

Notice According to GNU General Public License Version 2

This product includes software that is subject to the GNU General Public License version 2. The program is free software and distributed without any warranty of the author. We offer, valid for at least three years, to give you, for a charge no more than the costs of physically performing source distribution, a complete machine-readable copy of the corresponding source code.

Contents

Contents	1
Chapter I: Product Information	2
1-1 Introduction	2
1-2 Safety Information	3
1-3 Package Contents	4
1-4 Familiarizing Yourself with Your New Wi-Fi Extender	5
Chapter II: Extender mode	8
2-1 Extender Mode Quick Installation Guide	8
2-1-1 Hardware WPS Button Setup	10
2-1-2 Web browser quick setup	14
2-2 Extender Mode Advanced Settings	21
2-2-1 Connecting to the web configuration menu	21
2-2-2 Home	23
2-2-3 WPS Setting	25
2-2-4 Advanced Settings	28
2-2-5 MAC Address Filtering	32
2-2-6 System Settings	38
2-3 Resetting the Extender with the Hardware Reset Button	46
Chapter III: Appendix	47
3-1 Configuring TCP/IP on PC	47
3-1-1 Windows XP IP Address Setup:	47
3-1-2 Windows Vista/Windows 7 IP address setup:	48
3-2 Specifications	51
3-3 Glossary	52
3-4 Technical Support Information	55

Chapter I: Product Information

1-1 Introduction

Thank you for purchasing this universal Wi-Fi extender! The ultra-compact design with built-in power allows you to install this extender anywhere, and receive excellent network performance in extending Wi-Fi signals and wireless coverage.

Other features of this Wi-Fi extender include:

- Extend the wireless signal inside your home or office.
- Ultra-compact design while maintaining excellent network performance.
- LED signal indicator to easily find the best location placement for Wi-Fi signal extension and optimal wireless performance.
- Hardware WPS (Wi-Fi Protected Setup) button for easy installation and wireless security.

1-2 Safety Information

In order to ensure the safety of users and this device, please follow the following safety instructions:

1. This Wi-Fi extender is designed for indoor use only. **DO NOT** expose this device to direct sunlight, rain, or snow.
2. **DO NOT** put this device in or near hot or humid places, such as the kitchen or bathroom. Also, do not leave this Wi-Fi extender in a car during the summer.
3. Do not allow children to put any small parts of this Wi-Fi extender in their mouths, as it could cause serious injury or could even be fatal. If they throw this Wi-Fi extender, it will be damaged. **PLEASE KEEP THIS WI-FI EXTENDER OUT THE REACH OF CHILDREN!**
4. This Wi-Fi extender will become hot after a period of use (this is normal and is not a malfunction). **DO NOT** put the Wi-Fi extender on paper, cloth, or other flammable materials after the Wi-Fi extender has been used for a long time.
5. There are no user-serviceable parts inside the Wi-Fi extender. If you find that the Wi-Fi extender is not working properly, please contact your dealer of purchase and ask for help. **DO NOT** disassemble the Wi-Fi extender by yourself, warranty will be voided.
6. If the Wi-Fi extender falls into water, **DO NOT USE IT AGAIN UNTIL YOU SEND THE DEVICE TO THE DEALER OF PURCHASE FOR INSPECTION.**

1-3 Package Contents

Before you start to use this Wi-Fi extender, please check if there's anything missing from the package, and contact your dealer of purchase to claim any missing items:

- 1 x Wi-Fi extender
- 1 x Ethernet cable
- 1 x Access key card
- 1 x Quick installation guide
- 1 x CD with user manual and multi-language QIG

1-4 Familiarizing Yourself with Your New Wi-Fi Extender

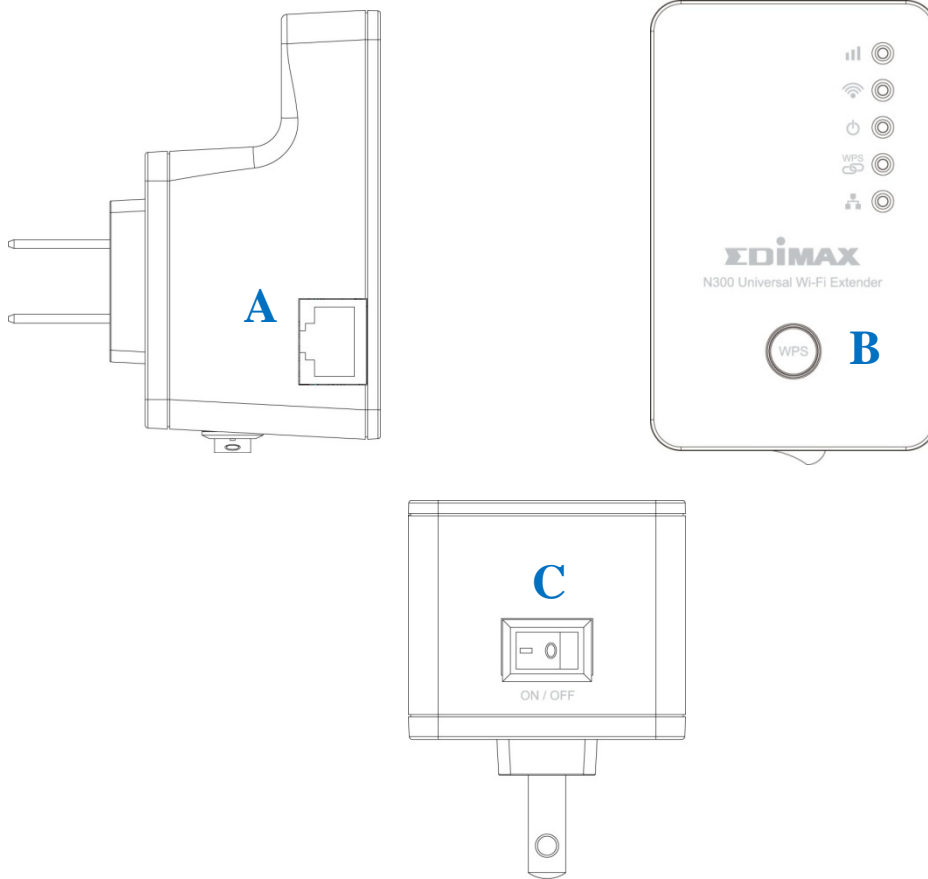

Interface Descriptions



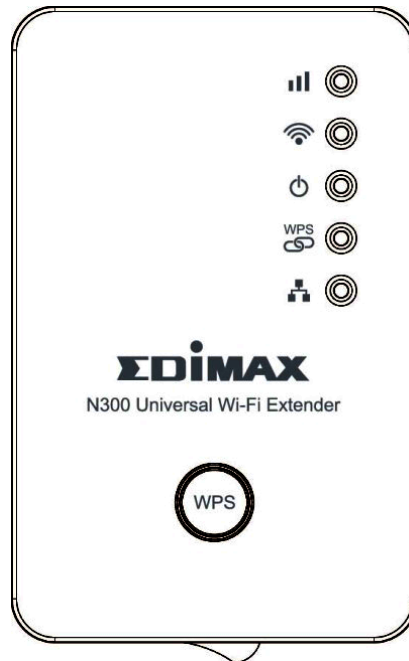

Item	Item Name	Description
A	LAN Port	10/100M Ethernet LAN Port with Auto-MDI/MDI-X. Connects to a computer, switch or hub for local network sharing.
B	Reset / WPS	Resets the extender to factory default settings (clears all settings) or starts the WPS function. Press this button and hold for 10 seconds to restore all settings to factory defaults. Press this button for less than 5 seconds to start the WPS function.
C	ON/OFF	This is the power on/off switch. If you want to switch off the extender, flip the switch to OFF.

LED Definitions



LED Name		LED Status	Description
	Signal Strength	On	Excellent signal reception (Signal strength 50 – 100%)
		Flashing	Good signal reception (Signal strength 25 – 50%)
		Flashing Rapidly	Poor signal reception (Signal strength < 25%)
		Off	No signal detected, disconnected, or in LED off mode
	Wi-Fi	Flashing	Transferring data
		Off	Wi-Fi not activated or in LED off mode
	Power	On	Device switched on and correctly powered
		Flashing	Resetting to factory defaults
		Off	Device not powered, not correctly powered, or in LED off mode

	WPS	On	WPS connection established
		Flashing	WPS in progress (waiting for another WPS device's connection)
		Flashing Rapidly	WPS error
		Off	No WPS connection established or in LED off mode
	LAN	On	LAN port connected
		Flashing	LAN activity (transferring data)
		Off	LAN port not connected

Chapter II: Extender mode

In extender mode, the Wi-Fi extender receives a wireless signal from a root wireless access point or router. It then repeats the signal it receives. This repeated signal can then be detected and used by other wireless devices, such as notebook computers, smartphones, and tablet computers.

This extends wireless signal coverage and helps solve problems with wireless dead zones.

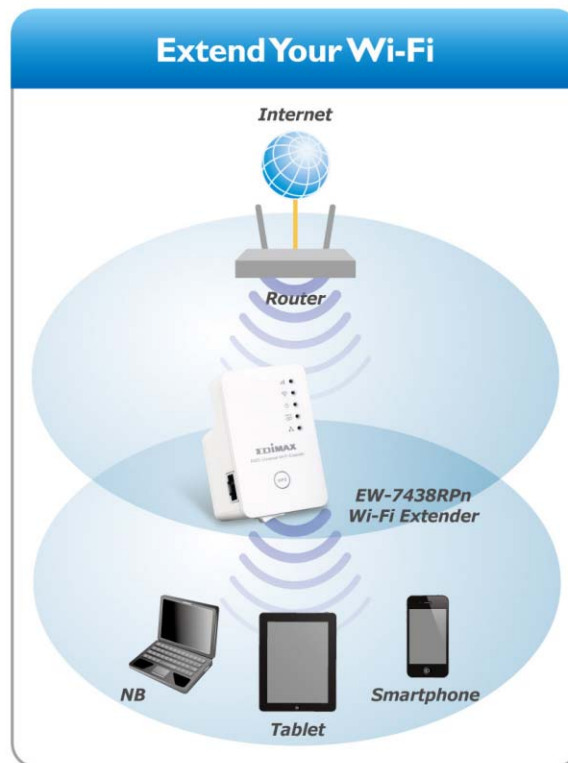



This chapter will show you how to quickly install this device with Wi-Fi Protected Setup, and how to set up the extender with the browser based user interface.

2-1 Extender Mode Quick Installation Guide

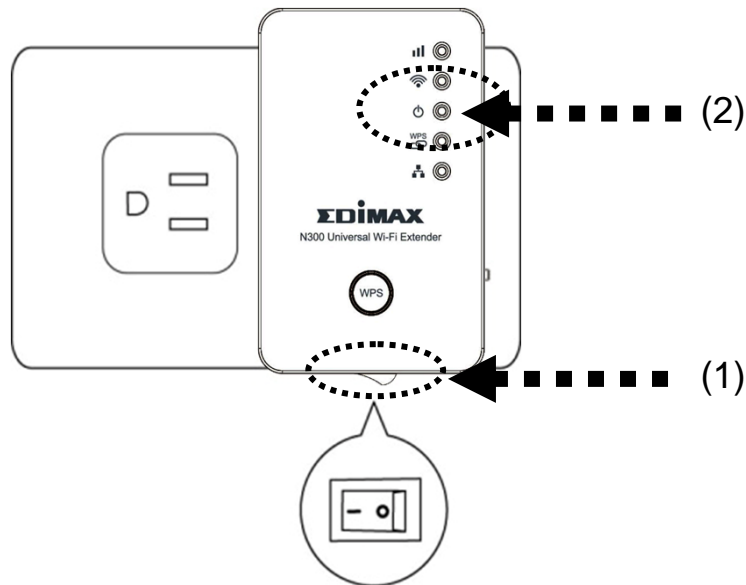
It is recommended that you first set up this extender somewhere close to the root wireless access point, and then move this extender to another location for optimal Wi-Fi extension. After installation is complete and the wireless connection is established, you can then move this extender to the location you wish to install it.



Plug the Wi-Fi extender into a power outlet close to the root wireless access point and switch it on (1). The extender will automatically initialize.

In a few seconds, the Power LED () will light up. Approximately 30 seconds later, the Wi-Fi LED () will begin to flash rapidly and irregularly (2). This indicates initialization is complete. Please do not proceed to the next step until these conditions are fulfilled.

You can establish a wireless connection via the hardware WPS button or using the web UI interface.

If your broadband router or access point also has a WPS button, we recommend using the WPS button to establish a connection. It is faster, secure, and does not require a computer.

Using WPS button

- please go to section 2-1-1

Using web UI

- please go to section 2-1-2

2-1-1 Hardware WPS Button Setup

1. Press and hold the **WPS button** on the extender for 2 seconds, until the **WPS LED** starts flashing.

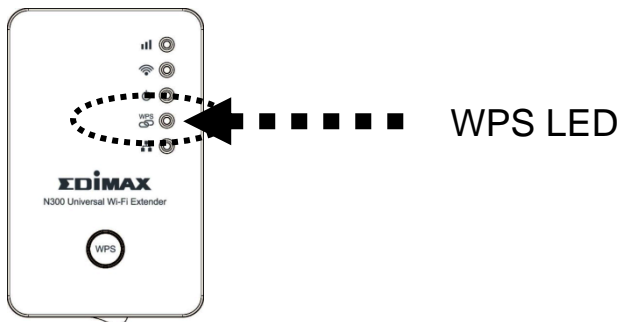
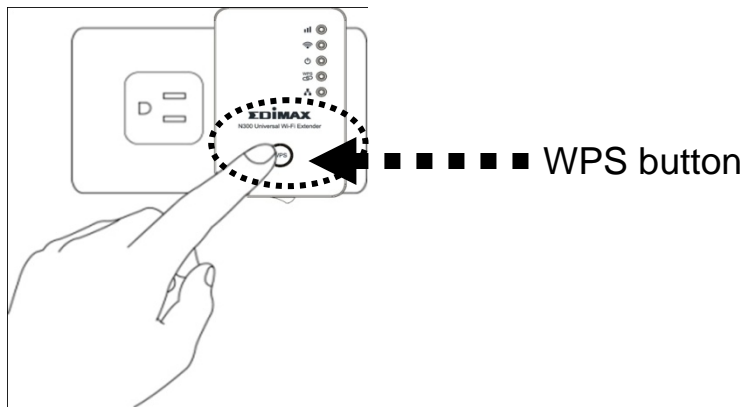

2. Press the **WPS button** on the root wireless access point within 2 minutes to establish a connection. The amount of time the button should be held down will vary between different routers, some will work with a quick press, while others may require holding the button down for 2 seconds or more.

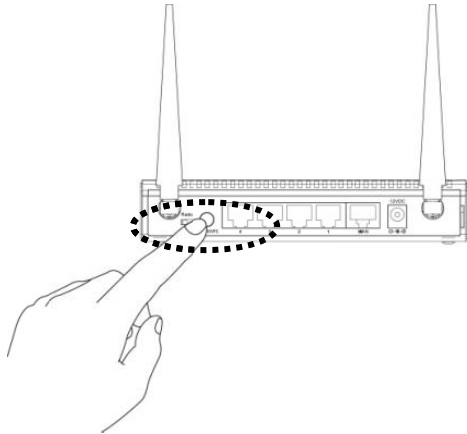

Note: This WPS button position on this access point is an example, different devices may have different WPS button positions. If the access point you wish to connect to does not have a hardware WPS button, you may be able to use its web configuration menu's WPS function to establish a connection. Alternatively, you can log in to this extender's web UI to set up the device (for more details, please refer to '2-1-2 Web Browser Quick Setup')

When the extender detects the WPS signal from the root wireless access point, the following sequence of LED flashes will occur:

Phase	WPS LED Sequence	Approximate Time
Phase 1	Blinks approximately 5 to 7 times	10 to 14 seconds
Phase 2	Turns OFF	3 seconds
Phase 3	Turn back ON solid	20 seconds
Phase 4	Turns OFF	14 seconds
DONE	Turn back ON solid	Continuous

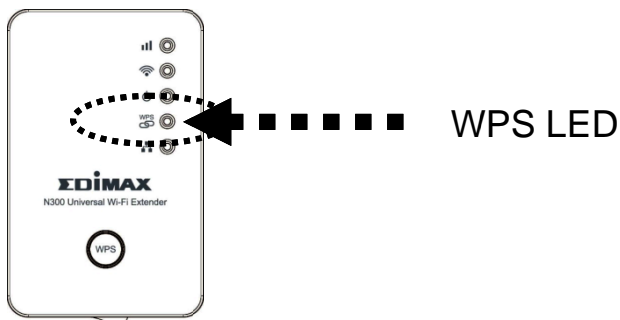

When a WPS connection has been successfully established, the *Signal Strength LED* will also light up in orange.

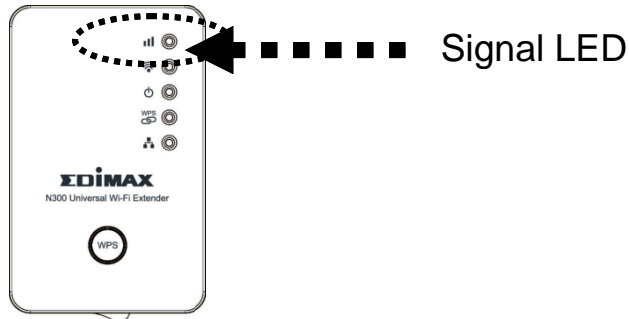

Note: If the WPS LED continues to blink in two-second intervals without moving on to Phase 2, then the Wi-Fi extender did not detect the WPS signal from the access point. Please return to step (2).



If an error occurred, the WPS LED will flash rapidly. Please wait for the WPS LED to deactivate and try again from step (1).

5 minutes after a WPS connection has been established, the WPS LED will automatically deactivate. This is intended behavior. The WPS connection between the extender and the wireless access point will remain active.

(3) Please move the extender to the location you wish to use it (a good place will be the center of your house) and insert this extender into a power outlet on the wall. The wireless connection to the root access point will be reestablished automatically.

You can check the '*Signal*' LED status to see the signal reception level.

Steady light:	Excellent
Flashing:	Good
Flashing rapidly:	Poor



Note: If the Signal LED is off, it means this location is out of the wireless signal range of your wireless broadband router or access point, please move this extender closer¹² to the broadband router until the extender can receive a signal from the broadband router and extend its signal.

The quick installation setup is now done, you can refer to '2-2 Extender mode Advanced Settings' to login to the web UI for other advanced settings.

2-1-2 Web browser quick setup

Before you can connect to the extender and start configuration procedures, your computer must be able to get an IP address automatically (use dynamic IP address). If it's set to use static IP address, or you're unsure, please refer to '*Chapter III: Appendix, 3-1 Configuring TCP/IP on PC*' to set your computer to use dynamic IP address.

1. Use an Ethernet cable to connect your computer's Ethernet port and the Wi-Fi extender's Ethernet port.

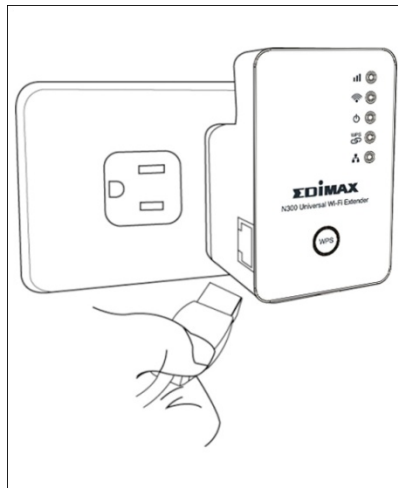

Or connect your computer to the extender through a wireless connection. Search for the available Wi-Fi networks in the area and connect to “extender*****”, where ***** is a series of numbers and letters. For example, in the following example, you would connect to “extender3a8270”.

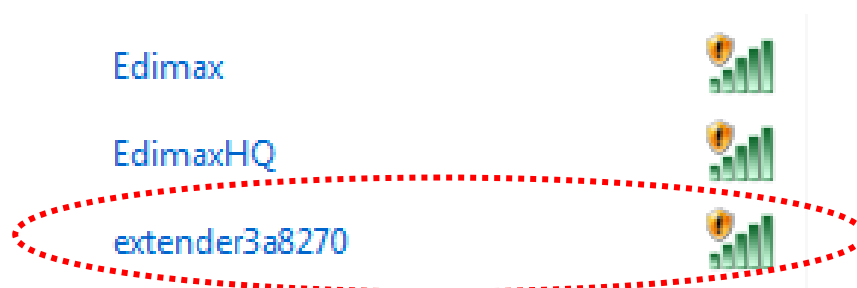



Note: If you are using Windows 7 and the following appears, please click “Connect the network without setting it up”. Please do not click “OK”.



Note: If you have accidentally clicked “OK”, you will see the following. Please click “Cancel”, and then return to step 1.



2. Now you should be connected to the Wi-Fi extender. There are two ways to access the web configuration interface:

Method 1 (Windows PCs only):

Open your web browser and input the access key in the address bar to log in to the extender's web configuration interface.



Note: The access key can be found on the access key card in the box and on the Wi-Fi extender.

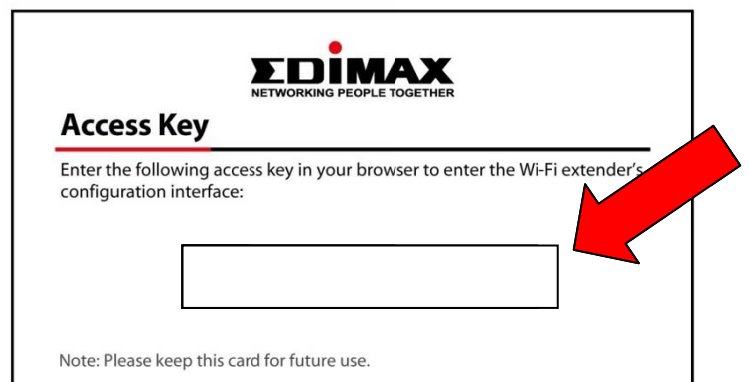
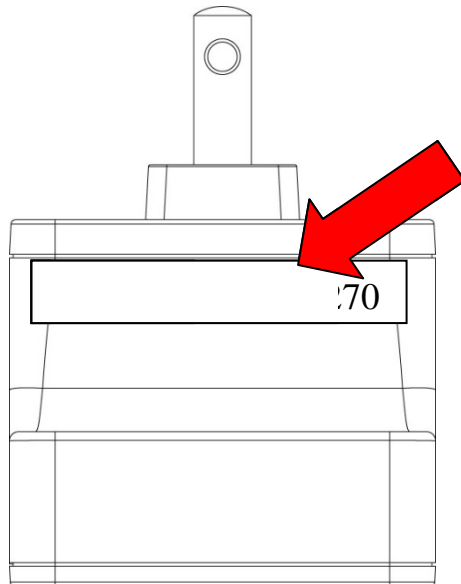

Method 2 (Windows, Macintosh, and Linux):

Enter the extender's default IP address (192.168.2.2) into your browser's address bar.

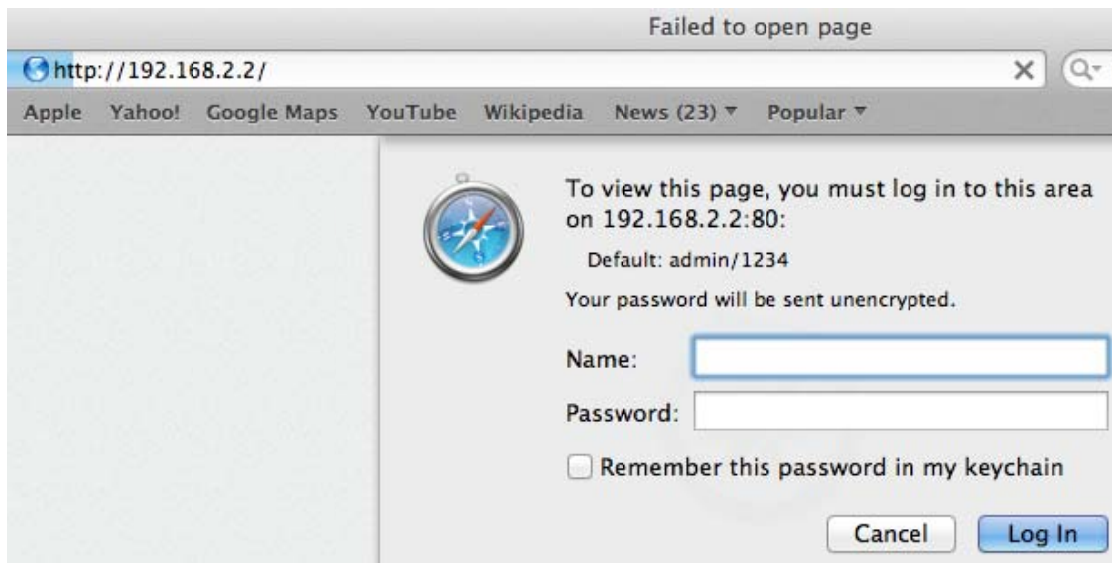

3. You will then be prompted to log in. The default username is “admin” and the default password is “1234”. Click “OK” to continue.

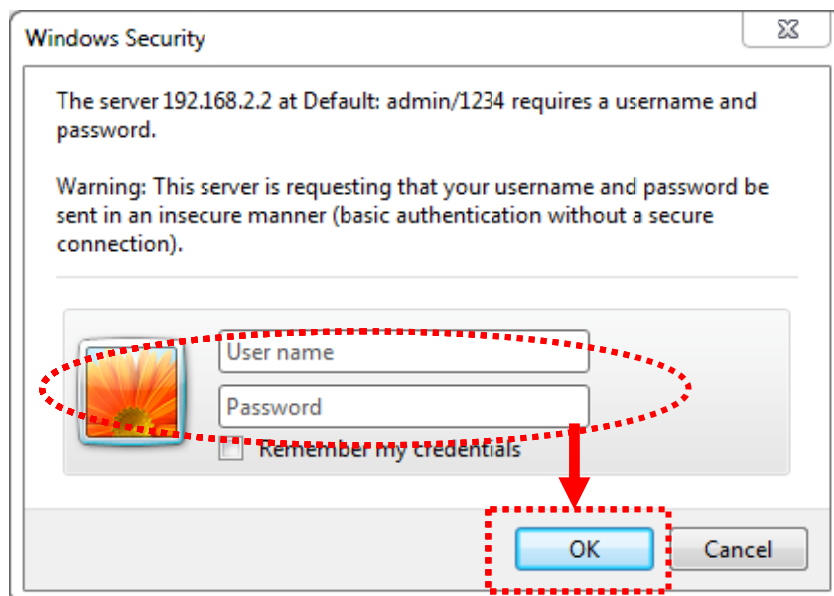

4. iQ Setup will start detecting available Wi-Fi networks automatically. All the detected Wi-Fi networks will be displayed in the list. Select the one to which you wish to connect and click “Next” to continue. If the Wi-Fi network you wish to connect to does not appear, click “Refresh” to search again or try moving the extender closer to the root wireless access point.

iQ Setup

Please connect this device to one of the following Wi-Fi networks.

Select	SSID	Channel	Encryption	Signal
<input checked="" type="radio"/>	Edimax	11	WPA-PSK	78
<input type="radio"/>	BR-6225HPn	8	no	44



Note: If you have set the SSID on your root AP to be hidden, please type in the information manually.

SSID :

5. You will be prompted to enter the extender's SSID and the access point's wireless security key. The default extender SSID is the root wireless access point's SSID plus the last six characters of the extender's access key. You may keep the default SSID, or enter a new one.

For the wireless security key, input the same key as the existing Wi-Fi network in the "Key" field. Click "NEXT" to continue.

Select	SSID	Channel	Encryption	Signal
<input checked="" type="radio"/>	Edimax	11	WEP	70
Device SSID: Edimax4E8968				
Key:				
<input type="radio"/>	EdimaxHQ	9	no	66



Note: The extender must have the same Wi-Fi password as the root wireless access point. Entering an incorrect password will result in the extender failing to connect to the root access point, or your computer failing to connect wirelessly to the Internet through the extender.

You may choose to save the setup page to your browser bookmarks list, for easier access in the future. This option is turned on by default.

6. After you click “NEXT” the Wi-Fi Extender will start to verify the wireless key with your associated access point and will show you result within 2 minutes. The setup page will indicate if the test has been successful. If the following page appears, click “NEXT” to continue:

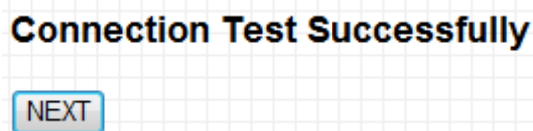

7. Click “APPLY” to complete the setup.



8. Please wait for few seconds for Wi-Fi extender to reboot.

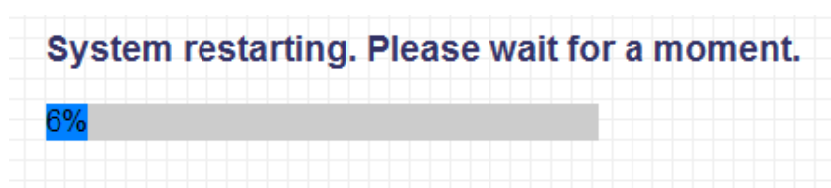

9. After the reboot is complete, your computer will disconnect from the extender. You can reconnect to it wirelessly by selecting the extender’s SSID in your list of Wi-Fi networks.



Note: After the wireless connection between the extender and the wireless broadband router is established, the extender becomes a DHCP client and will receive its IP address from the broadband router automatically. If you want to log in to the web UI of the extender, please refer to ‘2-2 Extender Mode Advanced Settings’ for more information.

2-2 Extender Mode Advanced Settings

2-2-1 Connecting to the web configuration menu

There are two ways to connect to the web configuration menu.

Method 1 (**Windows PCs only**)

After connecting to the Wi-Fi extender, open a new web browser window (IE, Firefox, Chrome etc.) and input the extender's access key (in the format `http://extender*****`) into address bar, then press the ENTER key:



Method 2 (**Windows, Macintosh, and Linux**):

After connecting to the Wi-Fi extender, open a new web browser window (IE, Firefox, Chrome, Safari etc.) and enter the extender's default IP address (192.168.2.2) into your browser's address bar.

Regardless of which method you use, the Wi-Fi extender will prompt you to enter a user name and password. The default user name is '**admin**' and password is '**1234**'. Click the 'OK' button to continue.

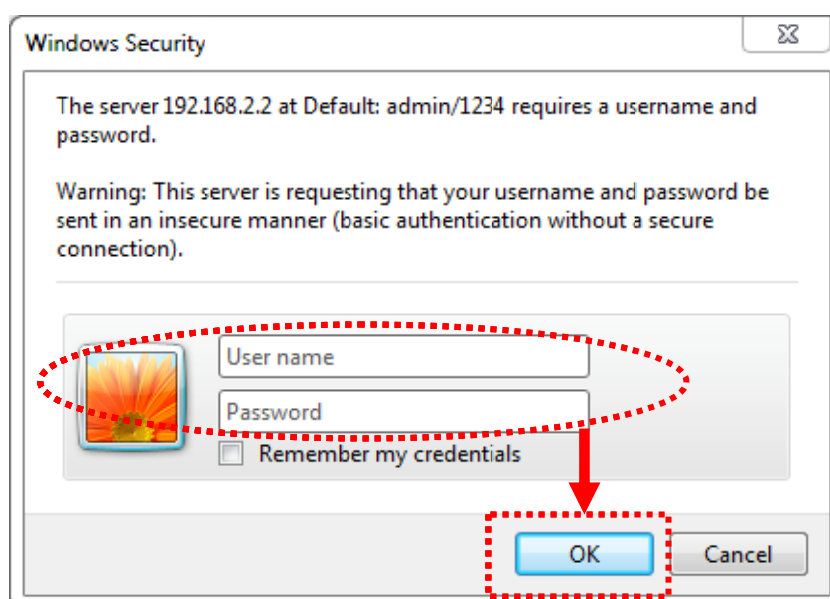

The configuration screen will appear shortly:

EDIMAX
NETWORKING PEOPLE TOGETHER

English

Status and Information

You can check the device's MAC address, runtime code, hardware version, and network status below.

System	
Uptime	0day:0h:5m:42s
Hardware Version	Rev. A
Runtime Code Version	1.10

Wireless Settings	
Mode	Universal Repeater
ESSID	Edimax4E8968
Channel Number	11
Security	WEP
BSSID (MAC)	80:1F:02:4E:89:68
Associated Clients	1 <input type="button" value="Show Active Clients"/>
State	Connected

2-2-2 Home

The status and information of this Wi-Fi extender will be displayed here.

To access the 'Home' menu, click 'Home' on the left.

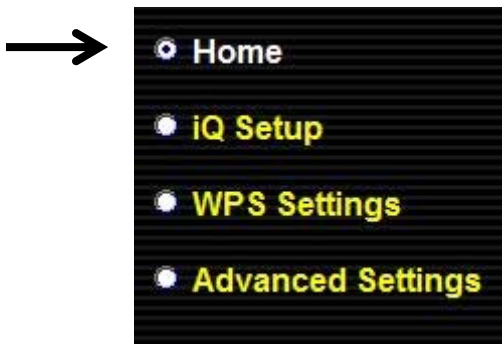

You should see something similar to the following screen (the contents will vary depending on your actual settings):

System	
Uptime	0day:0h:29m:40s
Hardware Version	Wireless Settings
Runtime Code Version	1.00c
Wireless Settings	
Mode	Universal Repeater
ESSID	OBM_MKT
Channel Number	11
Security	WPA-Shared Key
BSSID (MAC)	00:1f:1f:b1:0e:30
Associated Clients	0 <input type="button" value="Show Active Clients"/>
State	showText(information_21)
LAN Settings	
IP Address	192.168.2.2
Subnet Mask	255.255.255.0
Default Gateway	0.0.0.0
MAC Address	00:1f:1f:b1:0e:30

You can click the 'Show Active Clients' button to show all connected wireless clients.



Note: When you click the ‘Show Active Clients’ button, a new browser window will appear. Some browsers automatically block pop-up windows, so please disable pop-up blocking or you will not be able to use the ‘Show Client’ feature.

2-2-3 WPS Setting

You can configure WPS (Wi-Fi Protected Setup) here. By using WPS, you can quickly establish a secure connection between this Wi-Fi extender and other wireless devices that also support WPS.

To access the 'WPS Settings' menu, click 'WPS Settings' on the left.

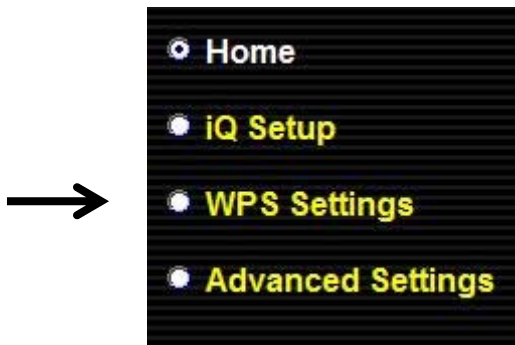

The following setup page will appear:

<input checked="" type="checkbox"/> Enable WPS	
• Wi-Fi Protected Setup Information	
WPS Status:	Configured
Device PIN Code:	16972001
SSID:	OBM_MKT
Authentication Mode:	WPA-Shared Key
Passphrase Key:	*****
• Device Configuration	
(AP/Router) Config Mode:	Registrar ▼
Configure via Push Button:	<input type="button" value="Start PBC"/>
Input Client PIN Code :	<input type="text"/> <input type="button" value="Send PIN"/>

The description of every setup item is listed as follow:

Item	Description
Enable WPS	You can enable or disable the WPS feature. Disabling WPS here will also disable the hardware WPS button. WPS is enabled by default.
WPS Status	Shows the security setting status of WPS. If the Wi-Fi extender's security has been configured, whether manually or automatically through the WPS button, the WPS status entry will be 'Configured'.
Device PIN Code	This is an 8-digit number for WPS PIN-style configuration. When another WPS-compatible device wishes to connect to this Wi-Fi extender and supports PIN type WPS, input this number into the wireless device to establish a connection.
SSID	Shows the SSID of this Wi-Fi extender.
Authentication Mode	Shows the authentication mode of this Wi-Fi extender.
Passphrase Key	The key is shown in asterisks (*) to indicate wireless security is properly set.
Config Mode	There are 'Registrar' and 'Enrollee' modes for the WPS connection. When 'Registrar' is enabled, the wireless clients will follow the extender's wireless settings for WPS connection. When 'Enrollee' mode is enabled, the extender will follow the wireless settings of the wireless router for WPS connection.
Configure via Push Button	Click 'Start PBC' to start Push-Button style WPS setup procedures. This Wi-Fi extender will wait for WPS requests from another wireless device for 2 minutes. The 'WPS' LED on the Wi-Fi extender will blink for 2 minutes while this Wi-Fi extender waits for incoming WPS requests.
Input Client PIN Code	Please input the PIN code of the wireless client you wish to connect to, and click the 'Send PIN' button.

	The 'WPS' LED on the Wi-Fi extender will blink while this Wi-Fi extender waits for incoming WPS requests.
--	---



Note: For WPS2.0 compliance specifications, WEP and WPA-PSK do not support WPS connections. Some wireless devices may follow the latest WPS2.0 specifications, so we do not recommend using WEP or WPA-PSK, to avoid WPS interoperability problems.

2-2-4 Advanced Settings

You can configure advanced wireless settings on this page. Please note that these settings should not be configured by novice users. Configure these settings only when you understand what you're doing.

To access the 'Advanced Settings' menu, click 'Advanced Settings' on the left.

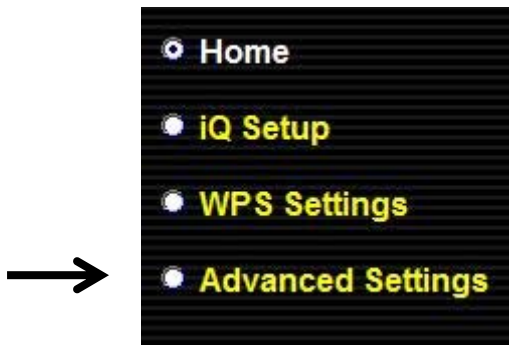

The following setup page will appear:

Fragment Threshold:	<input type="text" value="2346"/>	(256-2346)
RTS Threshold:	<input type="text" value="2347"/>	(0-2347)
Beacon Interval:	<input type="text" value="100"/>	(20- 1024 ms)
DTIM Period:	<input type="text" value="3"/>	(1-10)
Data Rate:	Auto ▾	
N Data Rate:	Auto ▾	
Channel Width:	<input checked="" type="radio"/> Auto 20/40MHz <input type="radio"/> 20MHz	
Preamble Type:	<input checked="" type="radio"/> Short Preamble <input type="radio"/> Long Preamble	
Broadcast ESSID:	<input checked="" type="radio"/> Enabled <input type="radio"/> Disabled	
WMM:	<input type="radio"/> Enabled <input checked="" type="radio"/> Disabled	
CTS Protect:	<input checked="" type="radio"/> Auto; <input type="radio"/> Always <input type="radio"/> None	
Tx Power:	100 % ▾	

- Enable LED Off Mode**
- Turn off all LED indicators
 - Turn off all LED indicators except the power LED

APPLY

CANCEL

Item	Description
Fragment Threshold	Set the fragment threshold. Do not modify the default value if you don't know what this does, default value is 2346.
RTS Threshold	Set the RTS threshold. Do not modify the default value if you don't know what this does, default value is 2347.
Beacon Interval	Set the beacon interval. Do not modify the default value if you don't know what this does, default value is 100.
DTIM Period	Configures DTIM (Delivery Traffic Indication Message) send period. Default value is 3.
Data Rate	<p>Select the wireless data transfer speed. When you select a value here, this extender will refuse to establish connections with wireless clients using other speeds.</p> <p>It's recommended you select 'Auto', which will allow this Wi-Fi extender to adjust speeds automatically.</p>
N Data Rate	<p>Select wireless data transfer speeds by MCS0 to MCS7. MCS stands for Modulation and Coding Scheme, which represents different speeds when the bandwidth is 20MHz or 40MHz.</p> <p>It's recommended to select 'Auto', which will allow this Wi-Fi extender to adjust speeds automatically.</p>
Channel Width	<p>Select the wireless channel width, 20MHz or 40MHz. 40MHz provides better network speed for 802.11n wireless clients.</p> <p>However, if there are 802.11b/g clients connecting to this Wi-Fi extender, it will switch to 20MHz mode automatically.</p>
Preamble Type	Set the preamble type, do not modify the default value if you don't know what this does, default

	setting is 'Short Preamble'.
Broadcast ESSID	When set to 'enabled', every wireless device will be able to scan for and find this Wi-Fi extender; when set to 'disabled', only wireless clients that know the extender's exact SSID can connect to the extender. Setting this to 'disabled' will help improve security.
WMM	Enable or disable Wireless Multi-Media. When enabled, the Wi-Fi extender will give priority to multimedia related network applications so they will have better performance.
CTS Protect	This feature provides CTS (Clear to Send) protection when transferring data. It's recommended to select 'Auto' for this option.
TX Power	Select wireless transmission power level, from 10% to 100%. When connected wireless clients are not too far from this Wi-Fi extender, then it is not necessary to select a higher power level. Higher power levels may allow other people to break into your wireless network when you have a bad password or no password.
Enable LED off mode	Enable or disable the Wi-Fi extender's LED lights. Check ' Enable LED OFF Mode ' to set up LED behavior: Turn off all LED indicators: disable all LED lights Turn off all LED indicators except the power LED: all LED lights will be disabled, except the 'POWER' LED

When you finish changing the settings on this page, click the 'APPLY' button. You'll see the following message:

Settings saved successfully!

Click CONTINUE to continue configuring other settings, or click APPLY to restart the system and make the changes take effect.

If you wish to continue configuring this Wi-Fi extender, click the 'CONTINUE' button; if you want to save changes and apply the changes, click the 'APPLY' button.

System restarting. Please wait for a moment.



You'll be prompted to wait for approximately 30 seconds before you can reconnect to the Wi-Fi extender.

2-2-5 MAC Address Filtering

This Wi-Fi extender can use its MAC address filter to only allow wireless users with certain MAC addresses to connect.

This will enhance security because you can make a ‘white list’ in advance, to only allow users on the list to use this Wi-Fi extender. Clients not on this white list cannot connect to the extender, even if the user knows the password.

To access the ‘MAC Filtering’ menu, click ‘MAC Filtering’ on the left.

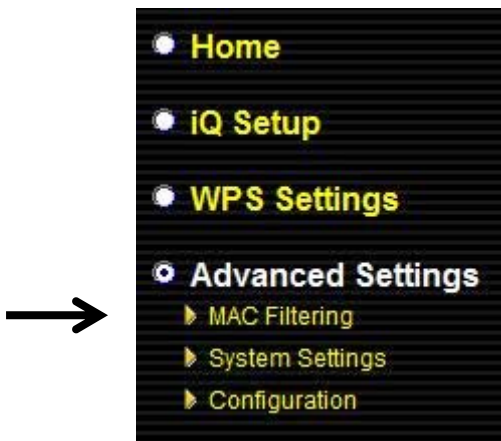

The following setup page will appear:

MAC Address Filtering

With MAC address filtering set up, only authorized MAC addresses can be associated to this device.

• MAC Address Filtering Table
Only 20 entries are allowed.

NO.	MAC Address	Comment	Select
1	11:22:33:44:55:66	Allowed Client	<input type="checkbox"/>

Enable Wireless Access Control

New MAC Address: Comment:

Item	Description
Enable Wireless Access Control	Check this box to enable MAC filtering. If you don't check this box, anyone who knows the wireless password can connect to this Wi-Fi extender.
MAC Address	Input the MAC address of the clients you wish to add to the white list. Please input only 12 hexadecimal characters here, without : (colon) or - (dash) characters every 2 characters. <i>If you don't know how to get the MAC address of a network client, please see tips below.</i>
Comment	Input any descriptive text about this MAC address, so you can remember the purpose of this entry. You can input up to 20 alphanumerical characters in this field.
Add	Add this MAC address to the list.
Clear	Clear the 'MAC Address' and 'Comment' fields.
Delete Selected	Delete MAC address(es) with the 'Select' box checked.
Delete All	Delete all MAC addresses in the list. You'll be prompted to confirm deletion first.
Reset	Uncheck all checked boxes.
Select	All entered MAC addresses will be listed here. To delete a MAC address from the list, check the box of the MAC address you wish to delete first. You can select more than one MAC address here.

When you finish changing the settings on this page, click the 'APPLY' button. You'll see the following message:

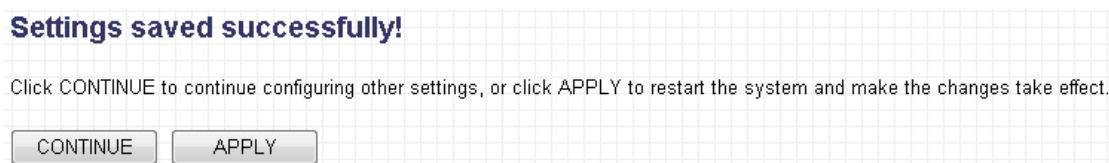

If you wish to continue configuring this Wi-Fi extender, click the 'CONTINUE' button; if you want to save changes and apply the changes,

click the 'APPLY' button. You'll be prompted to wait for 30 seconds before you can reconnect to this Wi-Fi extender.

TIP: *If you don't know the MAC address of your computer or wireless device, you can follow the following procedure:*

For wireless devices and computers which are connected to this Wi-Fi extender already, you can click the 'Show Active Clients' button in the 'Home' setting page.

Wireless Settings	
Mode	Universal Repeater
ESSID	OBM_MKT
Channel Number	11
Security	WPA-Shared Key
BSSID (MAC)	00:1f:1f:b1:0e:30
Associated Clients	0 <input type="button" value="Show Active Clients"/>
State	showText(information_21)

Their MAC address will be displayed in the 'MAC Address' field.

If you still can't identify the MAC address of your computer, you can follow the following procedure:

Click the network icon located at the lower-right corner, then click 'Open Network and Sharing Center'.

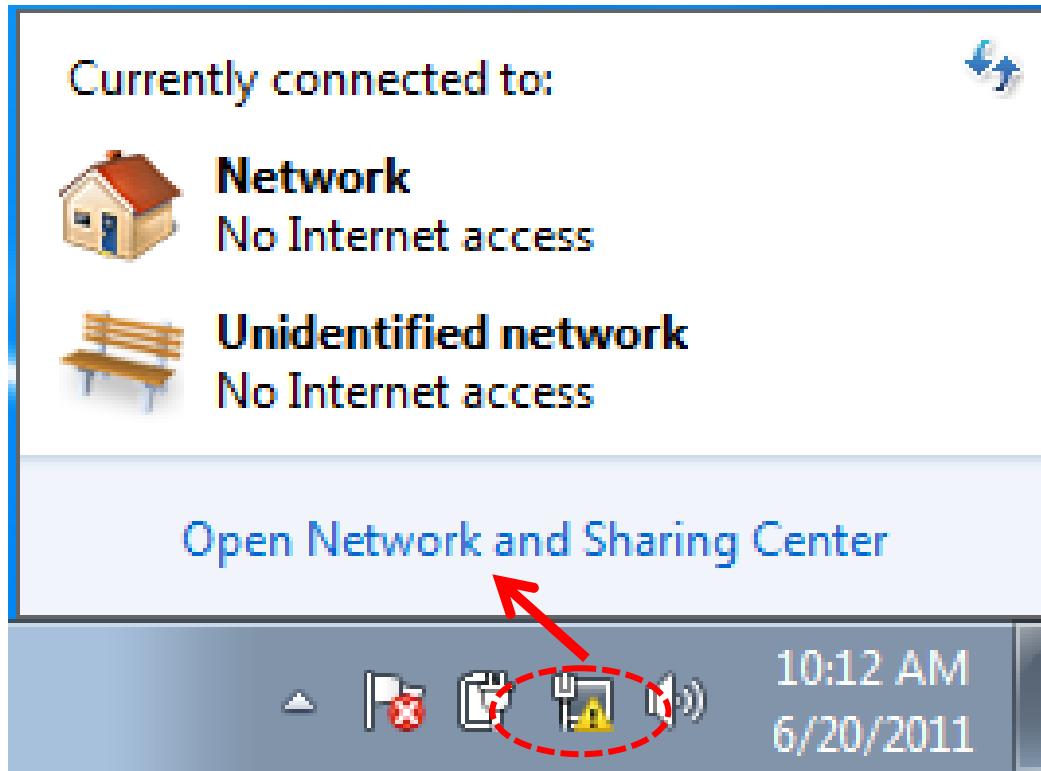

Select the connection that you'll be using to connect to the Wi-Fi extender (in this example, 'Local Area Connection'):

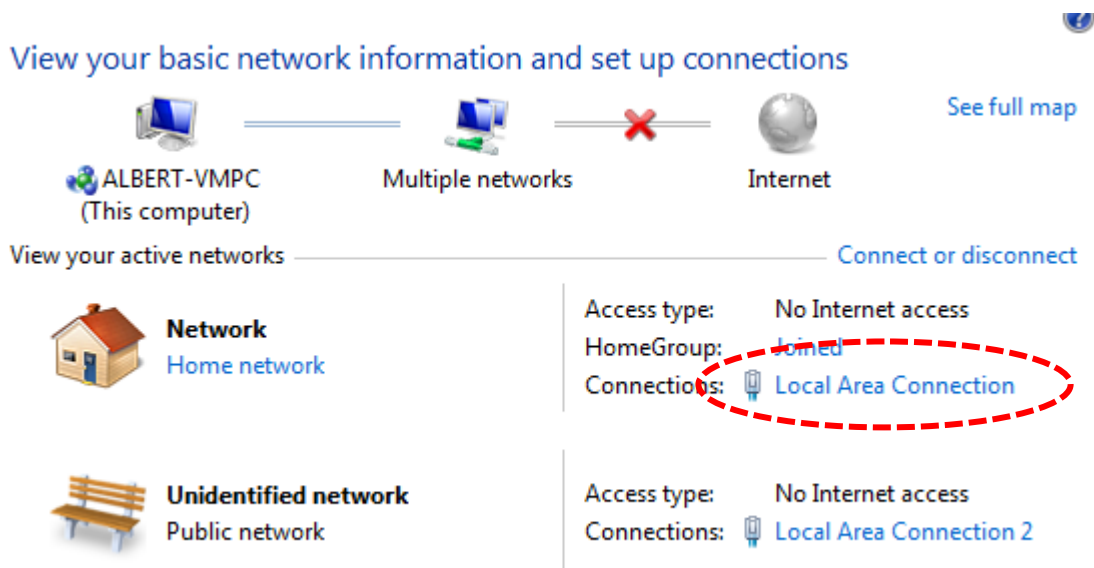

Click the 'Details...' button.

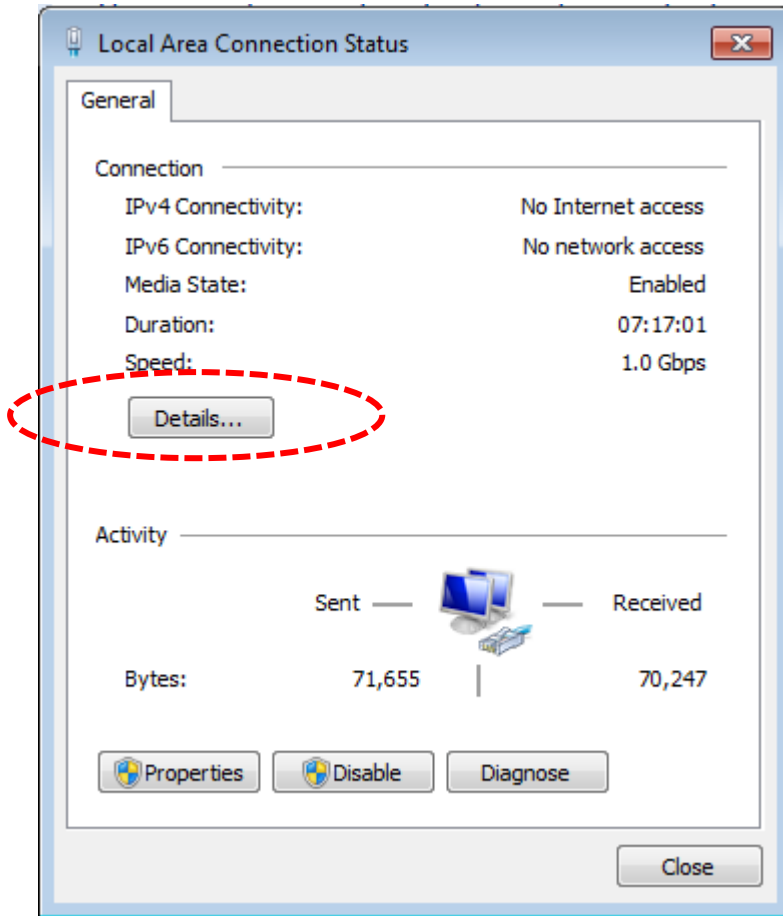

The MAC address of the selected network device will be displayed here as 'Physical Address'.

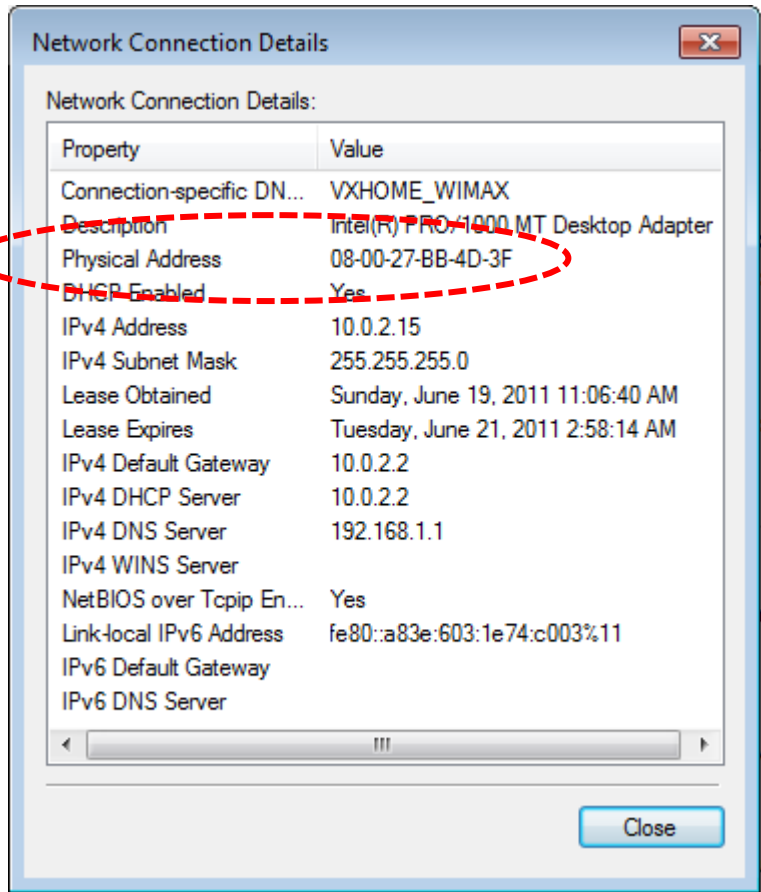

2-2-6 System Settings

You can change the settings of several system-level parameters on this page, including the administrator password, and IP address.

To access the 'System Settings' menu, click 'System Settings' on the left.

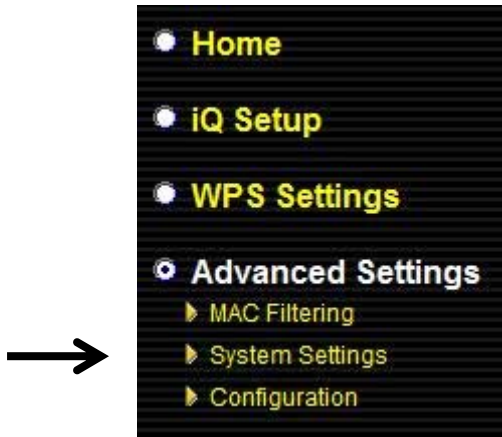

The following setup page will appear:

- **Password Settings**

Current Password :	<input type="text"/>
New Password :	<input type="text"/>
Re-Enter Password :	<input type="text"/>
- **Management IP**

<input checked="" type="radio"/> Obtain an IP address automatically :	
<input type="radio"/> Use the following IP address :	
IP Address :	<input type="text" value="192.168.2.2"/>
Subnet Mask :	<input type="text" value="255.255.255.0"/>
Gateway Address :	<input type="text"/>
- **DHCP Server**

DHCP Server :	<input type="text" value="Disabled"/>
Default Gateway :	<input type="text" value="192.168.2.2"/>
Domain Name Server IP :	<input type="text" value="0.0.0.0"/>
Start IP :	<input type="text" value="192.168.2.100"/>
End IP :	<input type="text" value="192.168.2.200"/>
Domain Name :	<input type="text" value="extender.com"/>
Lease Time :	<input type="text" value="Forever"/>

Password Settings

The default password of this extender is 1234, and it's displayed on the login prompt when accessed from a web browser. There's a security risk if you don't change the default password, since everyone can see it. This is very important when you have wireless functions enabled.

Item	Description
Current Password	To change the password, you have to input the current password first.
New Password	Input the new password here. You can use any combination of letters, numbers, and symbols up to 20 characters.
Re-Enter Password	Input the new password again for confirmation.

Management IP

Item	Description
IP Address	<p>Input the IP address of the LAN / Wi-Fi port of this Wi-Fi extender.</p> <p><i>NOTE: Please remember this IP address. If you forget this IP address and you didn't use the DHCP server function to assign IP addresses to clients, you'll not be able to connect to this Wi-Fi extender, and you'll need to clear all settings and passwords to reset the IP address back to the default value '192.168.2.2'. (Press the WPS button and hold for 10 seconds to restore all settings to factory defaults)</i></p>
Subnet Mask	Input the subnet mask of the IP address you're using.
Gateway Address	Input the network's gateway IP address. Generally you can use '0.0.0.0' (default value) since this Wi-Fi extender will access the Internet via a WAN port.

DHCP Server

Item	Description
DHCP Server	Choose "Enabled" to activate DHCP server functionality, "Disabled" to deactivate it.
Default Gateway	Enter the IP address of the default gateway.
Domain Name Server IP	Enter the IP address of the domain name server.
Start IP	Enter the starting IP address.
End IP	Enter the end IP address.
Domain Name	Enter the domain name for the device.
Lease Time	Select the lease time of the DHCP server.

When you finish changing the settings on this page, click the ‘APPLY’ button. You’ll see the following message:

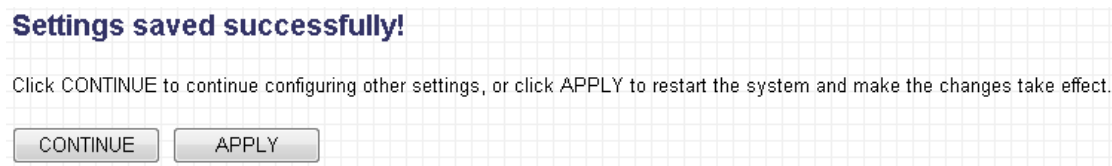

If you wish to continue configuring this Wi-Fi extender, click the ‘CONTINUE’ button; if you want to save changes and apply the changes, click the ‘APPLY’ button. You’ll be prompted to wait for 30 seconds before you can reconnect to this Wi-Fi extender.

2-2-7 Configuration

You can back up and restore the configuration of this Wi-Fi extender, so you can recall all settings in a very short time, without going through the process of configuration again.

This feature is especially useful when you need to use this Wi-Fi extender in different places, such as at home and in a hotel.

To access the 'Configuration' menu, click 'Configuration' on the left.

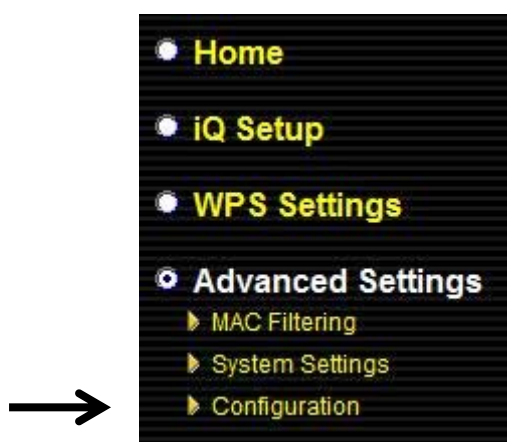

Configuration Tool

The following setup page will appear:

Backup Settings :	<input type="button" value="Save"/>
Restore Settings :	<input type="text"/> <input type="button" value="瀏覽..."/> <input type="button" value="Upload"/>
Restore to Factory Defaults :	<input type="button" value="Reset"/>

Item	Description
Backup Settings	Click the 'Save' button to save the current settings to a file on your computer.
Restore Settings	If you want to upload a saved configuration file to the Wi-Fi extender, please click the 'Browse' button to

	<p>select a saved configuration file on your computer. Then click the 'Upload' button to change the current settings to saved ones.</p>
<p>Reset to Factory Default</p>	<p>To reset all settings of this Wi-Fi extender to factory defaults, including the password. You'll be prompted to confirm the settings reset:</p> <div data-bbox="496 551 1350 891" data-label="Image"> </div> <p>Click 'OK' if you really want to restore all settings, or click 'Cancel' to abort.</p>

Upgrade

The software running in this Wi-Fi extender (i.e. 'firmware') can be upgraded to improve the functionality of this Wi-Fi extender.

You can visit our website to look for the latest firmware file. Then download the latest firmware file and save it on your computer, then upload it to this Wi-Fi extender.

Upgrade

This page allows you to upgrade the system's firmware. It is recommended that you upgrade the firmware with a wired connection.
Enter the path and name of the upgrade file and then click the APPLY button below. You will be prompted to confirm the upgrade.

Item	Description
Browse	Select a firmware file saved on your computer.

When you are ready, click the 'APPLY' button to start the firmware upgrade.



Note: DO NOT TURN OFF OR UNPLUG THE DEVICE WHILE THE UPGRADE IS IN PROGRESS.

Reset

When you think this Wi-Fi extender is not working properly, resetting it may help.

Reset

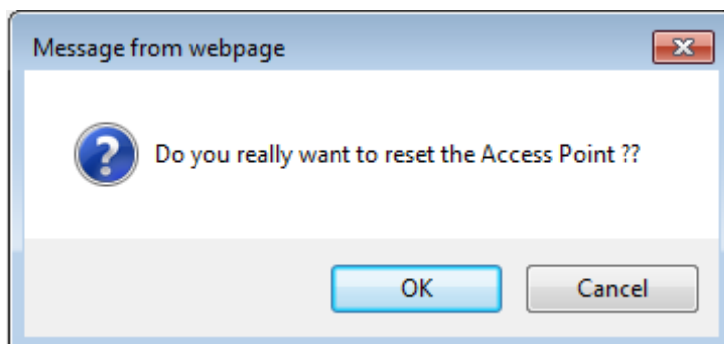

In the event that the system stops responding correctly or stops functioning, you can perform a reset. Your settings will not be changed. Click the APPLY button below to reset the device. You will be asked to confirm the reset.

To reset this Wi-Fi extender, click 'Apply' button. You'll be prompted to confirm the reset:



Click the 'OK' button to reset the Wi-Fi extender, or click 'Cancel' to abort.

2-3 Resetting the Extender with the Hardware Reset Button

If you find that the extender is not behaving as expected, it may help to reset the device. To reset the extender, press the WPS/Reset button and hold it down for 10 seconds, until the Power LED () begins to flash, then release the button. The extender will begin its initialization process. When the Power LED () stops flashing and stays on steadily, and the Wi-Fi LED () starts flashing rapidly, then the device has successfully reinitialized and is ready for further configuration.

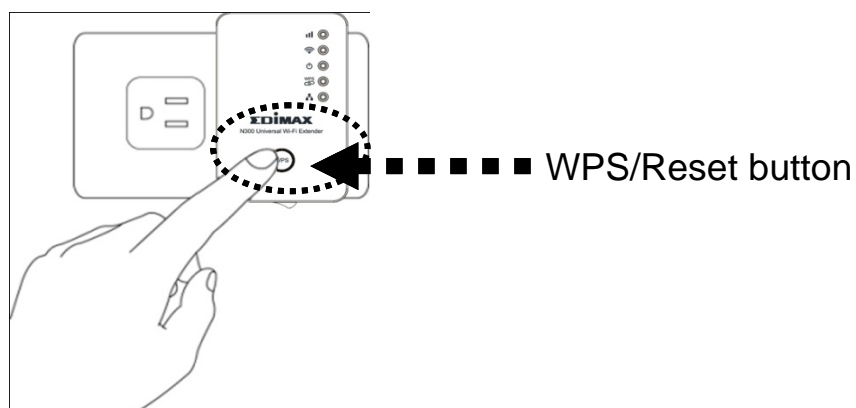

Note: To reset the device, hold down the WPS/Reset button and do not release it until the Power LED begins to flash, which should take around 10 seconds. Releasing the button too early may result in unintended behavior, such as the extender entering WPS connection mode.

Chapter III: Appendix

3-1 Configuring TCP/IP on PC

3-1-1 Windows XP IP Address Setup:

1. Click the 'Start' button (it should be located at lower-left corner of your computer), then click control panel. Double-click the *Network and Internet Connections* icon, click *Network Connections*, then double-click *Local Area Connection*, the *Local Area Connection Status* window will appear, and then click '**Properties**'

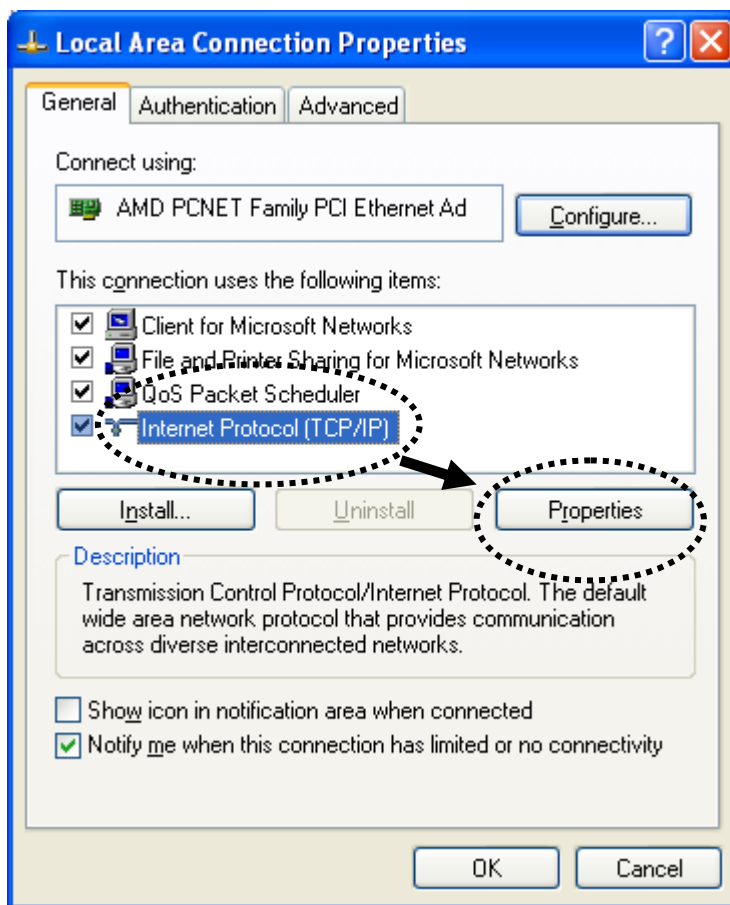

2. Select 'Obtain an IP address automatically' and 'Obtain DNS server address automatically', then click 'OK'.

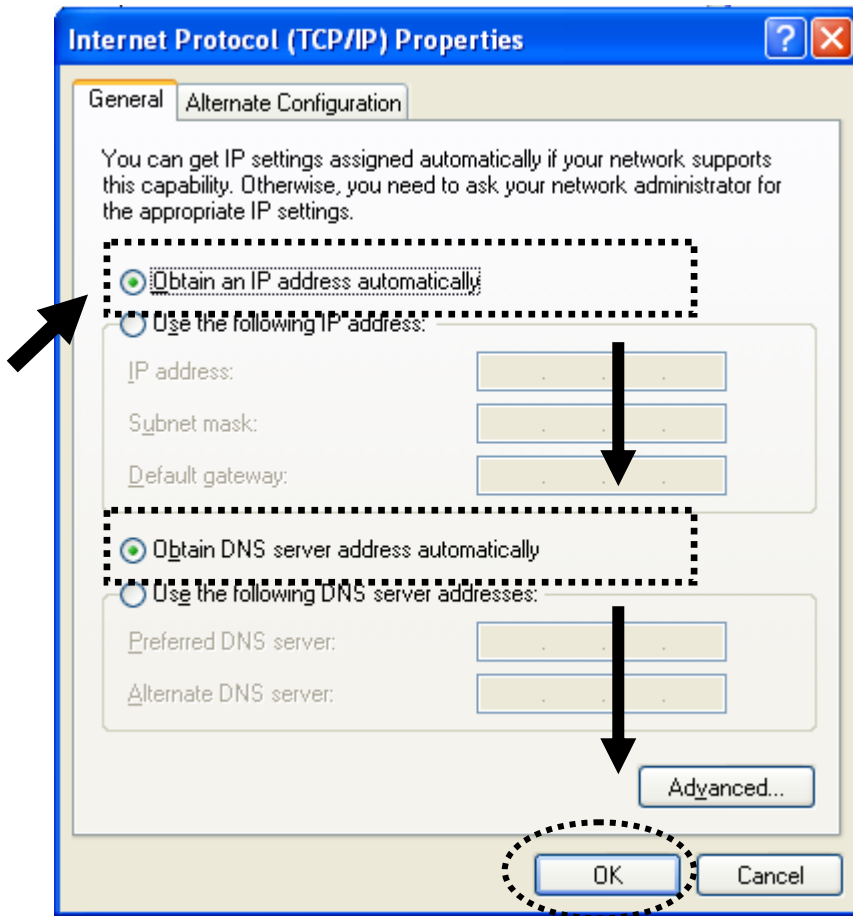

3-1-2 Windows Vista/Windows 7 IP address setup:

1. Click the 'Start' button (it should be located at the lower-left corner of your computer), then click control panel. Click ***View Network Status and Tasks***, and then click ***Manage Network Connections***. Right-click ***Local Area Network***, then select ***'Properties'***. The ***Local Area Connection Properties*** window will appear, select ***'Internet Protocol Version 4 (TCP / IPv4)'***, and then click ***'Properties'***

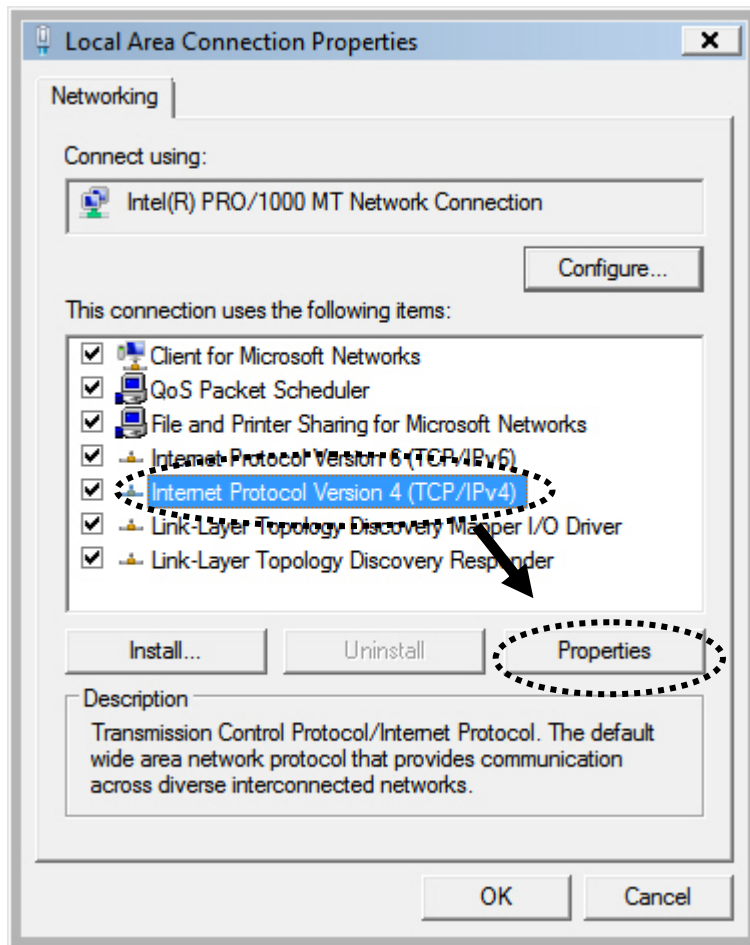

2. Select 'Obtain an IP address automatically' and 'Obtain DNS server address automatically', then click 'OK'.

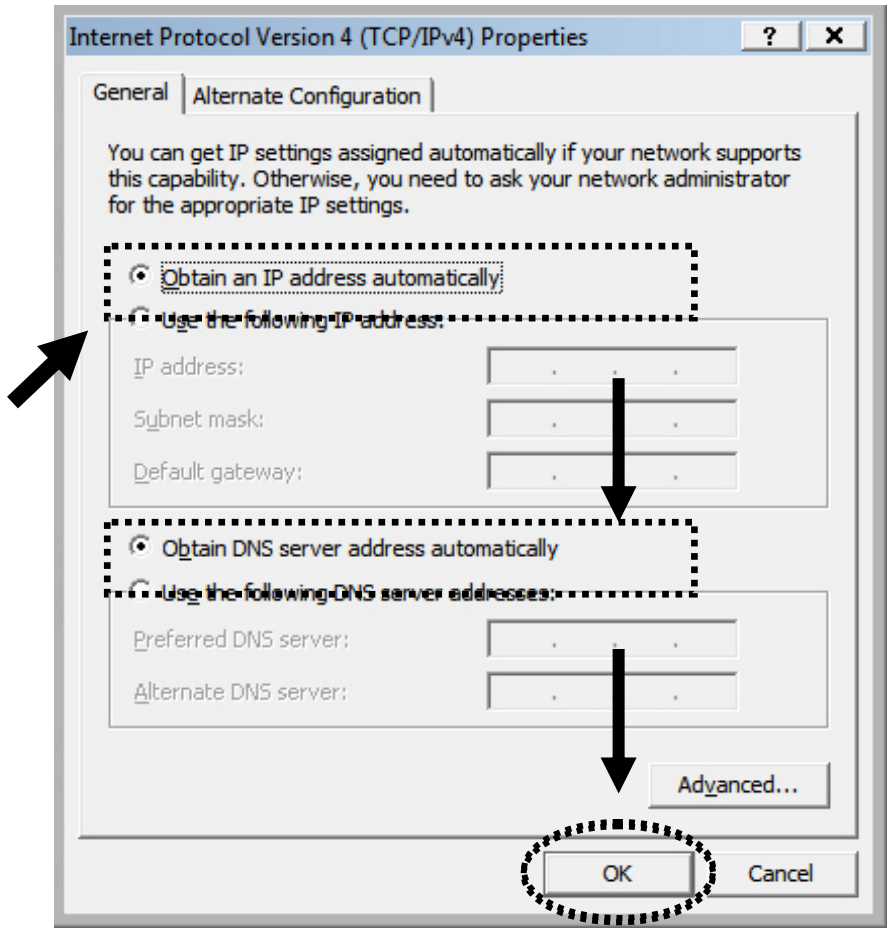

3-2 Specifications

SoC + RF: Realtek RTL8196CS+ RTL8192CE

Flash: 2MB

SDRAM: 16MB

LAN Port: 10/100M UTP Port x 1

Power: 5VDC, 1A Switching Power Module Inside

Dimension: 46.5(W) x 73(H) x 41(D) mm excluding power plug

Transmit Power: 11n: 13dBm±1.5dBm, 11g: 14dBm±1.5dBm, 11b: 17dBm±1.5dBm

Temperature: 32~104°F (0 ~ 40°C)

Humidity: 10-90% (Non Condensing)

Certification: FCC, CE

3-3 Glossary

1. What is the IEEE 802.11g standard?

802.11g is the new IEEE standard for high-speed wireless LAN communications, and provides for up to 54 Mbps data rates in the 2.4 GHz band. 802.11g is quickly becoming the next mainstream wireless LAN technology for home, office and public networks. 802.11g defines the use of the same OFDM modulation technique specified in IEEE 802.11a for the 5 GHz frequency band and applies it in the same 2.4 GHz frequency band as IEEE 802.11b. The 802.11g standard requires backward compatibility with 802.11b.

The standard specifically calls for:

- A. A new physical layer for the 802.11 Medium Access Control (MAC) in the 2.4 GHz frequency band, known as the extended rate PHY (ERP). The ERP adds OFDM as a mandatory new coding scheme for 6, 12 and 24 Mbps (mandatory speeds), and 18, 36, 48 and 54 Mbps (optional speeds). The ERP includes the modulation schemes found in 802.11b including CCK for 11 and 5.5 Mbps and Barker code modulation for 2 and 1 Mbps.
- B. A protection mechanism called RTS/CTS that governs how 802.11g devices and 802.11b devices interoperate.

2. What is the IEEE 802.11b standard?

The IEEE 802.11b Wireless LAN standard subcommittee, which formulates the standard for the industry. The objective is to enable wireless LAN hardware from different manufactures to communicate.

3. What does the IEEE 802.11 feature support?

This product supports the following IEEE 802.11 functions:

- CSMA/CA plus Acknowledge Protocol
- Multi-Channel Roaming
- Automatic Rate Selection
- RTS/CTS Feature
- Fragmentation
- Power Management

4. What is Ad-hoc?

An Ad-hoc integrated wireless LAN is a group of computers, each with a Wireless LAN card, connected as an independent wireless LAN. Ad-hoc wireless LAN is applicable at a departmental scale for

a branch or SOHO operation.

5. What is Infrastructure?

An integrated wireless and wireless and wired LAN is called an Infrastructure configuration. Infrastructure is applicable to enterprise scale for wireless access to central database, or wireless application for mobile workers.

6. What is BSS ID?

A specific Ad-hoc LAN is called a Basic Service Set (BSS). Computers in a BSS must be configured with the same BSS ID.

7. What is WEP?

WEP is Wired Equivalent Privacy, a data privacy mechanism based on a 40 bit shared key algorithm, as described in the IEEE 802 .11 standard.

8. What is TKIP?

TKIP is a quick-fix method to quickly overcome the inherent weaknesses in WEP security, especially the reuse of encryption keys. TKIP is involved in the IEEE 802.11i WLAN security standard.

9. What is AES?

AES (Advanced Encryption Standard), a chip-based security method, has been developed to ensure the highest degree of security and authenticity for digital information, wherever and however communicated or stored, while making more efficient use of hardware and/or software than previous encryption standards. It is also included in the IEEE 802.11i standard. Compared with AES, TKIP is a temporary protocol for replacing WEP security until manufacturers implement AES at the hardware level.

10. Can wireless products support printer sharing?

Wireless products perform the same function as LAN products. Therefore, wireless products can work with Netware, Windows 2000, or other LAN operating systems to support printer or file sharing.

11. Can the information be intercepted while transmitting over the air?

WLAN features two-fold protection in security. On the hardware side, as with Direct Sequence Spread Spectrum technology, it has the inherent security feature of scrambling. On the software side, WLAN series offer an encryption function to enhance security and Access Control. Users can set it up depending upon their needs.

12. What is DSSS? What is FHSS? And what are their differences?

Frequency-hopping spread-spectrum (FHSS) uses a narrowband carrier that changes frequency in a pattern that is known to both transmitter and receiver. Properly synchronized, the net effect is to maintain a single logical channel. To an unintended receiver, FHSS appears to be short-duration impulse noise. Direct-sequence spread-spectrum (DSSS) generates a redundant bit pattern for each bit to be transmitted. This bit pattern is called a chip (or chipping code). The longer the chip is, the greater the probability that the original data can be recovered. Even if one or more bits in the chip are damaged during transmission, statistical techniques embedded in the radio can recover the original data without the need for retransmission. To an unintended receiver, DSSS appears as low power wideband noise and is rejected (ignored) by most narrowband receivers.

13. What is Spread Spectrum?

Spread Spectrum technology is a wideband radio frequency technique developed by the military for use in reliable, secure, mission-critical communication systems. It is designed to trade off bandwidth efficiency for reliability, integrity, and security. In other words, more bandwidth is consumed than in the case of narrowband transmission, but the trade off produces a signal that is, in effect, louder and thus easier to detect, provided that the receiver knows the parameters of the spread-spectrum signal being broadcast. If a receiver is not tuned to the right frequency, a spread –spectrum signal looks like background noise. There are two main alternatives, Direct Sequence Spread Spectrum (DSSS) and Frequency Hopping Spread Spectrum (FHSS).

14. What is WPS?

WPS stands for Wi-Fi Protected Setup. It provides a simple way to establish unencrypted or encrypted connections between wireless clients and access point automatically. Users can press a software or hardware button to activate the WPS function, and WPS-compatible wireless clients and access points will establish a connection by themselves. There are two types of WPS: PBC (Push-Button Configuration) and PIN code.

3-4 Technical Support Information

Support documentation is available on the enclosed CD and on our global websites.

USA

Website: <http://www.edimax.us>

Email: support@edimax.com

Europe

Website: <http://www.edimax.eu/en/index.php>

Email: support@edimax.nl

UK

Website: <http://www.edimax.co.uk>

Email: support@edimax.co.uk

Germany

Website: <http://www.edimax-de.eu>

Email: support@edimax-de.eu

France

Website: <http://www.edimax.fr>

Email: support@edimax.fr

Middle East

Website: <http://edimax-me.com>

Email: technical.support@edimax-me.com

China

Website: <http://www.edimax.com.cn>

Email: service@edimax.com.cn

Taiwan

Website: <http://www.edimax.com.tw>

Email: support@edimax.com.tw



EDIMAX
NETWORKING PEOPLE TOGETHER

Edimax Technology Co., Ltd

6F., No.3, Wu-Chuan 3rd Road, Wu-Gu,
New Taipei City, Taiwan

Edimax Technology Europe B.V.

Nijverheidsweg 25 5683 CJ Best
The Netherlands

Edimax Computer Company

3350 Scott Blvd., Bldg.15 Santa Clara,
CA 95054, USA